



VMZ-S 3020



CNC Video Measuring System
NEXIV

NEXIV VMZ-S

High accuracy / High speed / Easy tolerance management at micro level.

Equipped with Nikon's excellent optical design

6 types of optical heads are each equipped with a 15x zoom capability, offering an optimum solution.

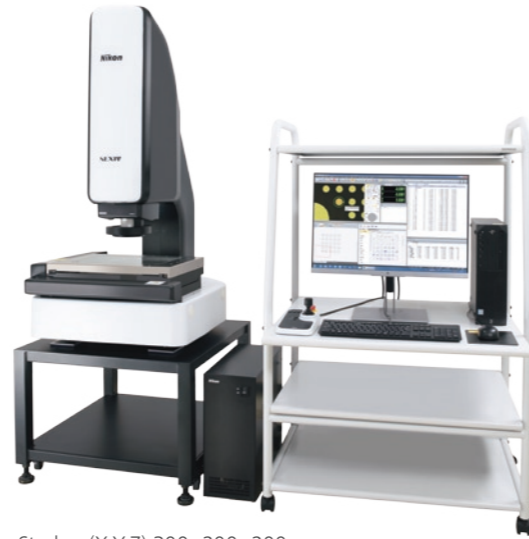

Strokes (X,Y,Z) 300x200x200 mm

Standard magnification zooming heads (Type 1, 2, and 3)

| Zooming heads | Optical magnification | Total magnification | FOV size on stage (mm) | Minimum measurement diameter (as a guide)* | |
|------------------------|-----------------------|---------------------|------------------------|--|-------------|
| Standard magnification | Type 1 | 0.5 – 7.5x | 18 – 270 | 9.33x7 – 0.622x0.467 | 221 – 15 μm |
| | Type 2 | 1 – 15x | 36 – 540 | 4.67x3.5 – 0.311x0.233 | 111 – 8 μm |
| | Type 3 | 2 – 30x | 72 – 1080 | 2.33x1.75 – 0.155x0.117 | 56 – 4 μm |

Connector, IC package, PCB, MLCC, Lead frame, Camera Module, Glass and Plastic Lenses, etc.

High magnification zooming head (Type 4 and TZ)

| | | | | | |
|--------------------|---------|----------|------------|-------------------------|--------------|
| High magnification | Type 4 | 4 – 60x | 144 – 2160 | 1.17x0.88 – 0.078x0.058 | 34 – 2.2 μm |
| | Type TZ | 1 – 120x | 36 – 4320 | 4.67x3.5 – 0.039x0.029 | 111 – 0.9 μm |

High density printed circuit board, fine semiconductor package, Micro Electro Mechanical (MEMS) parts, etc.

Wide FOV zooming head (Type A)

| | | | | | |
|----------|--------|-------------|------------|------------------|-------------|
| Wide FOV | Type A | 0.35 – 3.5x | 12.6 – 126 | 13.3x10 – 1.33x1 | 327 – 33 μm |
|----------|--------|-------------|------------|------------------|-------------|

Molded parts, Sheet metal stampings, rubber seals and parts, mechanical components, etc.

*This is not a guaranteed value. Sample: Calibration plate. diascopic light and measurement within FOV (without stage move). Diameter is calculated by creating least-squares circle from 36 measurement points. Please use this as a guide when choosing head types.



Printed circuit board (optical magnification 2x) Type 2 / 8 segment LED ring light

IC chip (optical magnification 8x) Type 4 / coaxial top light

Resin parts (optical magnification 0.35x) 8 segment LED ring light

High accuracy within the field of view (FOV)

Accuracy within FOV (P_{F2D} , P_{FV2D}) is specified. Nikon designed optics deliver high-quality images and realize accurate measurement data.

| | |
|-------------------------------------|-------------------|
| Probing error* | P_{F2D} 0.8 μm |
| Probing error of the imaging probe* | P_{FV2D} 0.3 μm |

*Type2 zooming head. Determined by Nikon in-house measurement method. Measurement of the perimeter of circular reference device. It involves stage movement which caliper within the FOV is evenly placed at 25 points on the perimeter.

*Type2 zooming head. Determined by Nikon in-house measurement method. Measurement of 25 points that are evenly placed on the perimeter of circular reference device at one location on the screen (without stage movement).

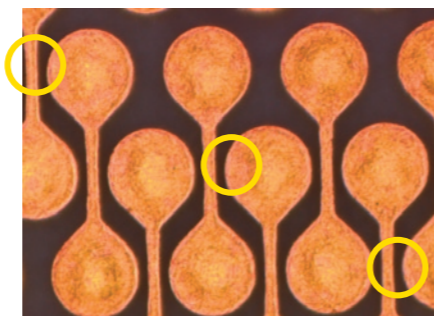

Micro wiring patterns (Type2 head, optical magnification 15x)

High reliability within the FOV.

Fast and high precision Auto-Focusing (2 Types)

Laser AF

Type 1, 2, and 3 zooming heads are equipped with TTL laser AF with a long working distance 50 mm. It can also be used for scanning the surface by detecting a maximum of 1000 points per second.

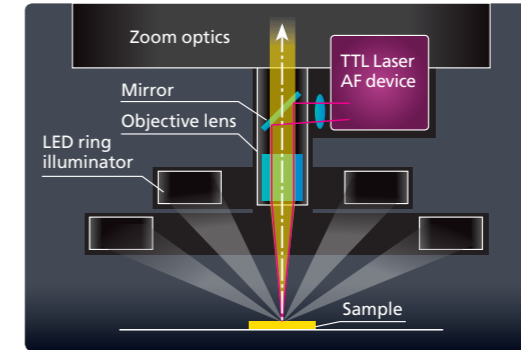

TTL Laser and AF schematic

Vision AF

Vision AF is suitable to measure the height of rough surfaces and depth of small/deep holes.

Versatile illumination designed for highlighting obscure edges

Standard NEXIV optical heads have episcopic, diascopic, and 8 segment LED ring illumination.



• LED inner ring light

• LED outer ring light at 55 degree position

• LED outer ring light at 78 degree position

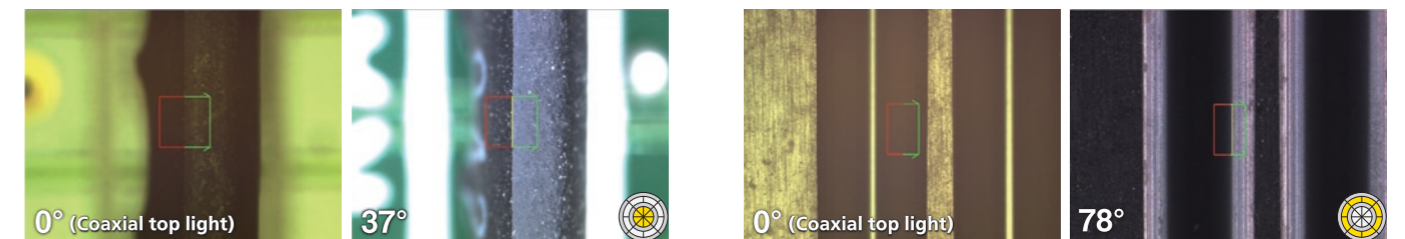

• Coaxial top light / 37 degree oblique light (Connector at optical magnification 5x)

• Coaxial top light / 78 degree oblique light (Drill at optical magnification 5x)

Obscure edges under coaxial top light are visible with LED ring lights.

Improvement of the throughput < NEW

Throughput has improved by realizing faster short-distance stage movements. This contributes to the shortening of the measurement time.

| | | |
|--------------------------------|----------|---------------------------|
| Conventional NEXIV (VMZ-R3020) | 182 sec. | 34% less Measurement time |
| VMZ-S3020 | 120 sec. | |

*Measurement of 625 (25x25) circle diameter. $\phi 50 \mu m$, Pitch: X,Y=0.2 mm, Stage speed: max, FOV: 0.58x0.44 mm. Same teaching file is used for measurement.

New design < NEW

Along with the exterior design change, the joystick used for stage and optical head movements has been redesigned to make the operation easier and less tiring during long use.



Software Easy to use, streamlined software suite

Dimension measurement software NEXIV AutoMeasure realizes high accuracy / high speed / easy measurement with valuable functions possible in a user-friendly GUI.

GUI for easier operations

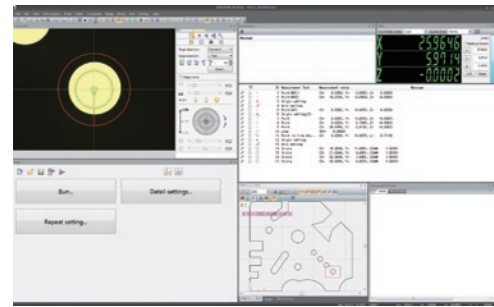

The graphical user interface (GUI) simplifies machine movement, creating and running teaching files, and clearly indicates status and progress of measurements.

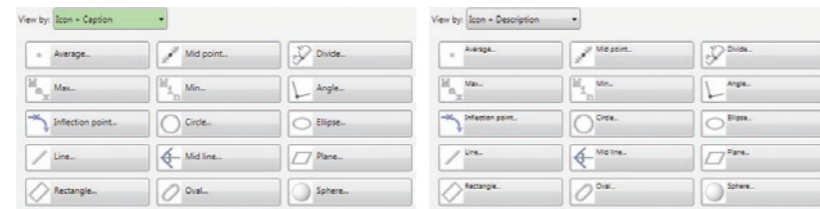

Change of indication of measure tools

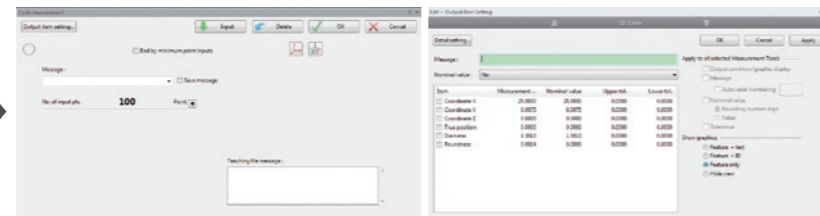

Main window changes its function according to situation.

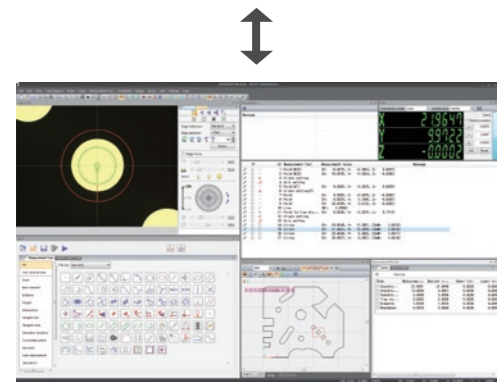

Various wizards for guiding procedures of measurements are available, providing fast, easy writing of teaching files. GUI can be customized for different tasks. You can select and hide functions for achieving your tasks.

Measurement programming support* < NEW

Supports part of the measurement program creating processes. By selecting the measurement point, several settings are handled by the system and measurement program code is created automatically.

Creating stitching image automatically

CAD data and image can be overlaid and compared automatically.

Creating measurement program code automatically

By selecting the shape you want to measure in the CAD/Image, the component shape is automatically recognized and a measurement program code is automatically created.

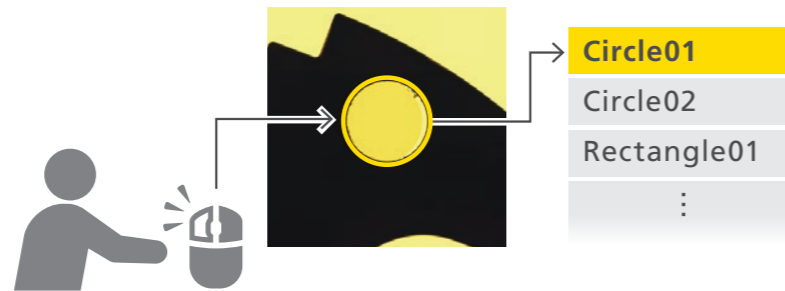

*This function is for workpieces with simple shape structure. Guide of conditions: With diascopic illumination. Components with perforations or voids which can clearly detect edge contours, without significant variations, or material contamination. (circle, rectangle, and circular arc)

Edge and point selection

Preset rules for selecting the correct edge with multiple edge candidates and the filter to avoid abnormal points in order to minimize errors.

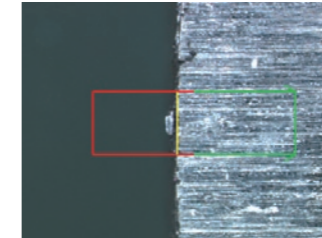

Intelligent search function

Measures by searching preset shapes/patterns. Misaligned samples can be found and measured without failure.

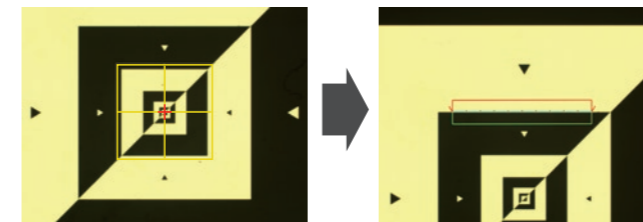

Automatically finds the shape that was set as a target

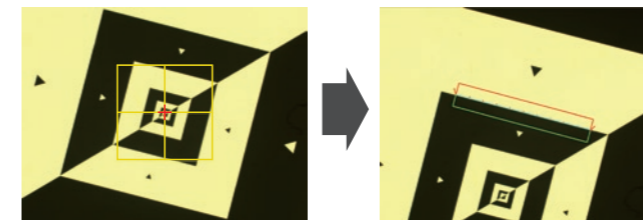

"Rotate search" detects the misaligned samples and automatically rotates the program to suit for measurement.

Evaluation of shapes

Errors can be visualized by overlaying nominal and measured shapes. Can be used for both geometrical shapes and free-form shapes.

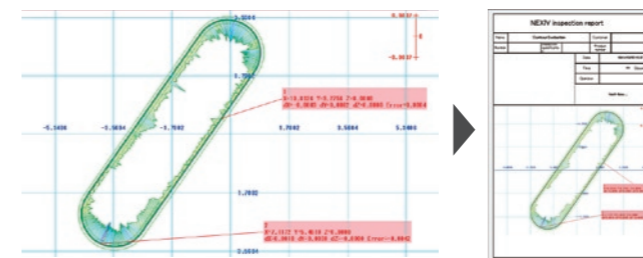

- Calculation of errors can be made in normal or axis direction
- Nominal shapes can be made from CAD data or XYZ coordinate values
- Measured shapes can be output as CSV or DXF files
- Evaluation reports can be made in PDF files

Digital operation guide NEXIV Note

The function offers slides and movie output together with NEXIV contents, such as basic operations and functions. Simple measurement programs can be created by referring to this application.

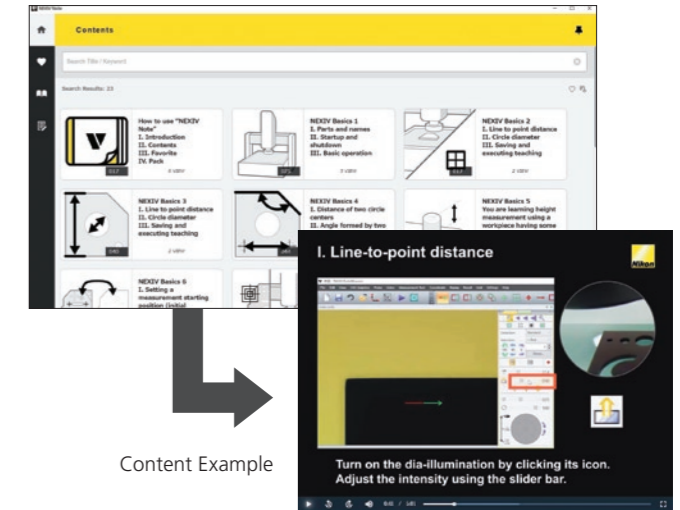

Content Example

Example of the function

- Memo: Share information by creating memos

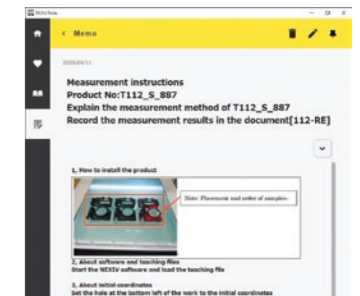

Other functions

Import of CAD data CAD data can be imported and shown in the graphic window.

Export of DXF data Features measured can be exported as DXF data.

Off-line teaching Teaching files can be made using CAD data.

Reporting measured data Easily made by choosing the required graphics and layouts.

Calculations based on ISO and JIS standards Circle (roundness), plane (flatness), line (straightness) are available.

Please contact your local Nikon partner.

Optional Software

EDF/Stitching Express

Images taken with the VMZ-S can be stitched to get a larger mosaic image, while images at different heights can result with an image with Extended Depth of Focus (EDF). Stitching and EDF can produce full 3D graphics.

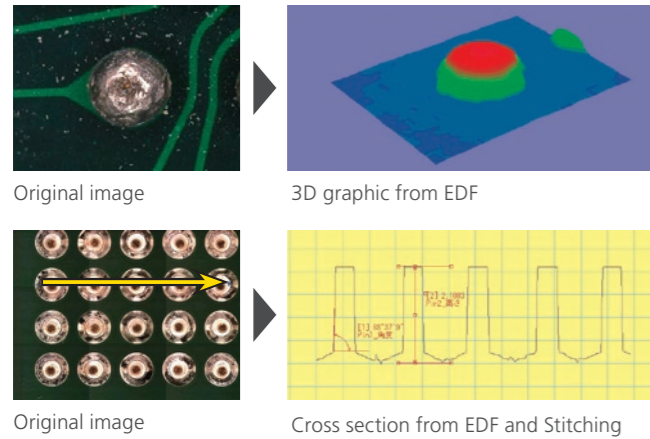

MountainsMap X

Sample surfaces can be analyzed, based on ISO, with the data exported from VMZ-S.

Provided for Nikon by Digital Surf (France)

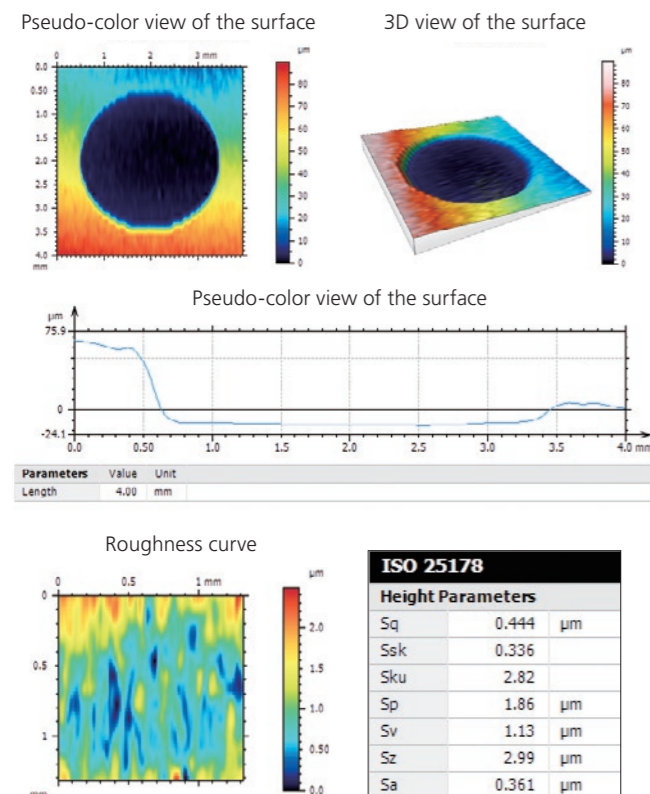

ImageFit QC

Creates inspection reports according to a designated format. Measurement results can be automatically be modified with a pass/fail result and statistical data.* Line graphs and histograms can also be created as needed.

*standard deviation, process capability index (Cp, Cpk)

*Excel is required

Codeveloped by Aria Co., Ltd. (Japan)

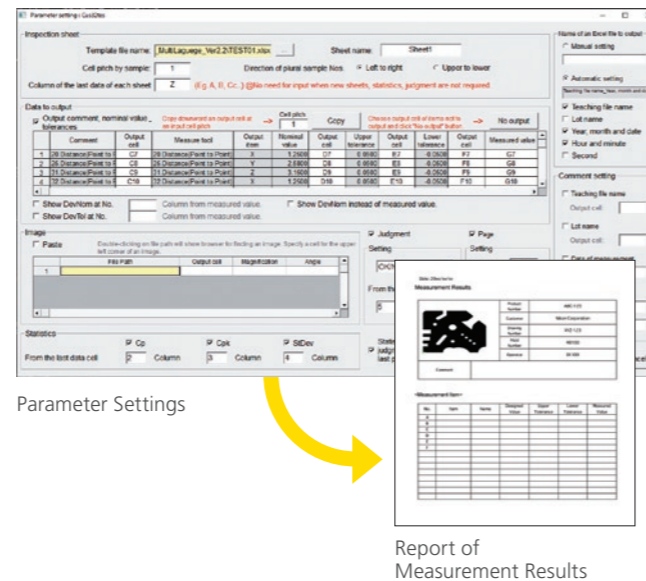

Custom Fit QC

Measurement results are read into 10 different templates and pass/fail results and calculation results*1 are automatically exported. Graphs*2, including X-R control charts and scatter diagrams, can be automatically generated to visualize measurement results.

*1: Average, maximum value, minimum value, range, standard deviation, and process capability index (Cp, Cpk)

*2: Line graphs, histograms, X-R control charts, scatter diagrams

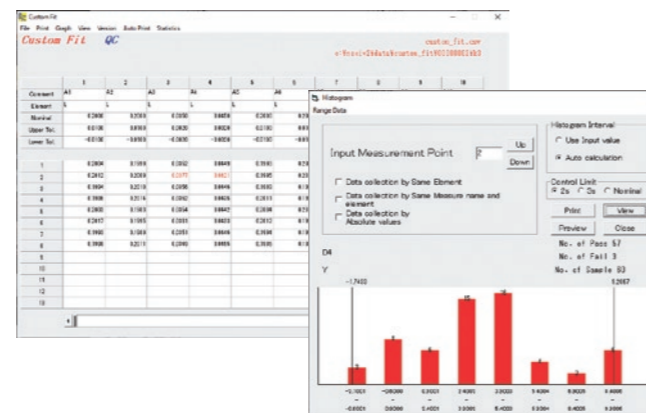

*Excel is required

Codeveloped by Aria Co., Ltd. (Japan)

3D CAD Converter

3DCAD model can be converted to 2DCAD(NCD) file, which can be used in NEXIV AutoMeasure. 2DCAD of the surface used for laser AF and scan laser can also be created. 3DCAD models are compatible with STEP and IGES files.

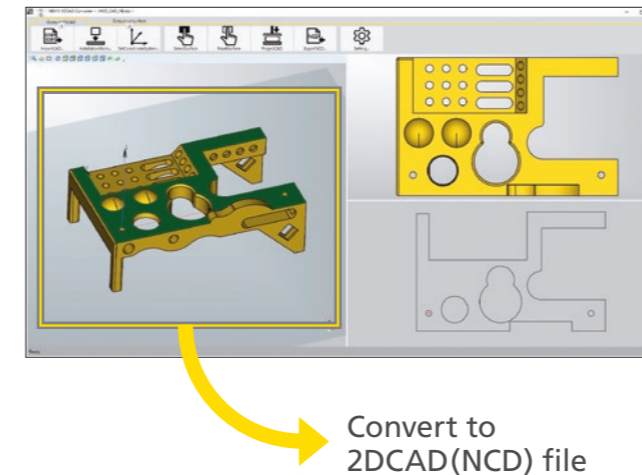

MapMeasure Pro

MapMeasure Pro creates wafer maps and is capable of automatically measuring any die on the wafer map. Tray maps can also be created.

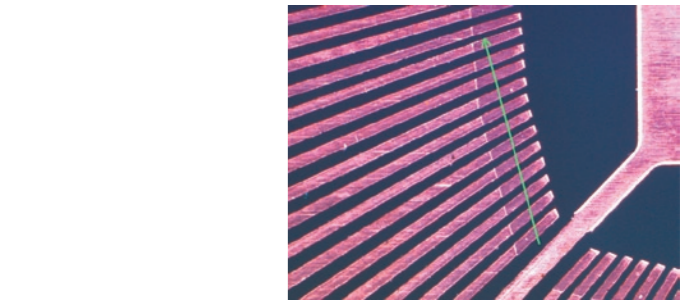
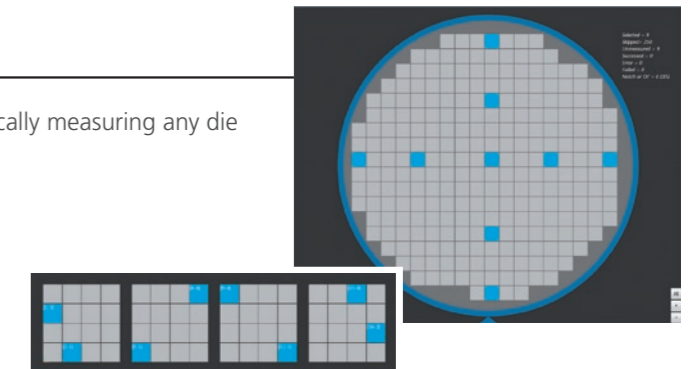

Auto-scan and measuring the lengths between the leads

Dimension VMZ-S3020

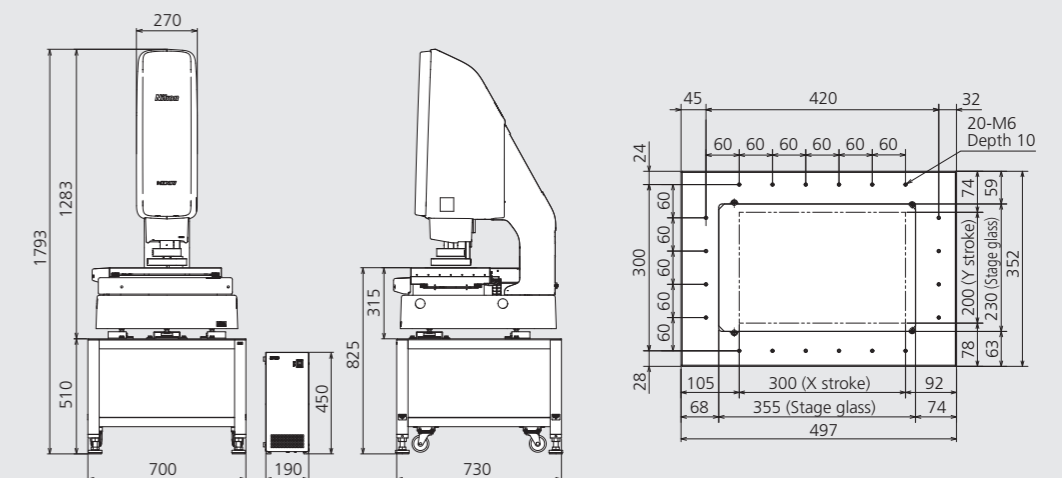

Specifications

| Model | | VMZ-S3020 | | | |
|--|---|---------------------------------|---|---|--|
| XYZ strokes | 300×200×200 mm *Type TZ with low magnification lens: 250×200×200 mm | | | | |
| Minimum readout | 0.01 μm | | | | |
| Maximum sample weight | 20 kg (Accuracy guaranteed: 5 kg) | | | | |
| Maximum permissible error (L: Length in mm) | EUX, MPE 1.2 + 4L / 1000 μm | EUXY, MPE 2.0 + 4L / 1000 μm | | Euz, MPE 1.2 + 5L / 1000 μm | |
| | Probing error ^{1),2)} : MPE P _{F2D} 0.8 μm Probing error of the imaging probe ^{1),2)} : MPE P _{FV2D} 0.3 μm | | | | |
| Camera | Black and White / Color 1/3 CMOS Camera | | | | |
| Working distance | Type 1, 2 and 3 50 mm | Type 4 30 mm | Type TZ (High-mag.) 11 mm / (Low-mag.) 32 mm | Type A 73.5 mm (63 mm with Laser AF) | |
| Autofocus | Laser AF (Option for Type A) / Image AF | | | | |
| Laser AF repeatability range ^{1),3)} | 2σ ≤ 0.5 μm | | | | |
| Illumination | Type 1, 2, 3, and 4 : Episcopic, diascopic, and 8-segment ring with 3 angles *All white LED/Type 4 has only 1 angle Type TZ: Left objective lens: Episcopic, darkfield ; Right objective lens: Episcopic, diascopic, darkfield Type A: Episcopic, diascopic, and 8-segment ring with 1 angle *All white LED | | | | |
| Power source, Power consumption | AC100 V-240 V, 50/60 Hz / 4 A – 2 A | | | | |
| Dimensions & weight | Main body with table (W×D×H): 700×730×1793 mm / approx. 265 kg Controller: 190×450×450 mm / approx. 12 kg | | | | |
| Footprint (W×D) | 2700×2400 mm | | | | |

1) Determined by Nikon in-house measurement method. 2) With Type 2 head, 15×. 3) Workpiece: Chrome on calibration plate, without Type A head.

VMZ-S series
scheduled to be released in 2021

VMZ-S4540 Stroke (X,Y,Z) 450×400×200 mm
VMZ-S6555 Stroke (X,Y,Z) 650×550×200 mm



Please contact Nikon for details.

Nikon Corporation Industrial Metrology Business Unit is certified as an ISO/IEC 17025 accredited calibration laboratory for CNC video measuring systems by the IAJapan (International Accreditation Japan) as Accreditation No.JCSS0241.

ISO/IEC 17025: International standard, which specifies the general requirements to ensure that a laboratory is competent to carry out specific tests and/or calibrations

| | |
|--|---|
| Date of initial accreditation: | November 22, 2010 |
| Scope of accreditation: | Coordinate measuring instruments |
| Accredited section: | Industrial Metrology Business Unit |
| Calibration site: | Customer's laboratory (field service) |
| Calibration and Measurement Capability (CMC), (K=2, Level of Confidence Approximately 95%) [L=measurement length (mm)] | L ≤ 420 mm: 0.32 μm 420 ≤ L ≤ 1000 mm: (0.29 + 0.64 × L/1000) μm |

Specifications and equipment are subject to change without any notice or obligation on the part of the manufacturer. December 2020 ©2020 NIKON CORPORATION
N.B. Export of the products* in this catalog is controlled under the Japanese Foreign Exchange and Foreign Trade Law. Appropriate export procedures shall be required in case of export from Japan.
*Products: Hardware and its technical information (including software)
Company names and product names appearing in this brochure are their registered trademarks or trademarks.

クラス1レーザ製品
CLASS 1 LASER PRODUCT



WARNING

TO ENSURE CORRECT USAGE, READ THE CORRESPONDING MANUALS CAREFULLY BEFORE USING THE EQUIPMENT.



NIKON CORPORATION

Shinagawa Intercity Tower C, 2-15-3, Konan, Minato-ku, Tokyo 108-6290, Japan
phone: +81-3-6433-3701 fax: +81-3-6433-3784
<https://www.nikon.com/products/industrial-metrology/>

ISO 14001 Certified
for NIKON CORPORATION

ISO 9001 Certified
for NIKON CORPORATION
Industrial Metrology Business Unit

NIKON METROLOGY EUROPE NV

Geldenaaksebaan 329, 3001 Leuven, Belgium
phone: +32-16-74-01-00 fax: +32-16-74-01-03
E-mail: Sales.Europe.NM@nikon.com
<http://www.nikonmetrology.com/en-gb>

NIKON METROLOGY UK LTD.

UNITED KINGDOM phone: +44-1332-811-349 fax: +44-1332-639-881
E-mail: Sales.UK.NM@nikon.com

NIKON METROLOGY SARL

FRANCE phone: +33-1-60-86-09-76 fax: +33-1-60-86-57-35
E-mail: Sales.France.NM@nikon.com

NIKON METROLOGY GMBH

GERMANY phone: +49-6023-91733-0 fax: +49-6023-91733-229
E-mail: Sales.Germany.NM@nikon.com

NIKON INSTRUMENTS S.p.A.

ITALY phone: +39-055-300-96-01 fax: +39-055-30-09-93

NIKON METROLOGY, INC.

12701 Grand River Avenue, Brighton, MI 48116 U.S.A.
phone: +1-810-220-4360 fax: +1-810-220-4300
E-mail: Sales.NM-US@nikon.com
<http://www.nikonmetrology.com/en-us>

NIKON CANADA INC.

CANADA phone: +1-905-602-9676 fax: +1-905-602-9953

NIKON MEXICO- Metrology Showroom

MEXICO phone: +52 (442) 688 5067
E-mail: Sales.NM-MX@nikon.com

NIKON INSTRUMENTS (SHANGHAI) CO., LTD.

CHINA (Shanghai branch) phone: +86-21-6841-2050 fax: +86-21-6841-2060
(Beijing branch) phone: +86-10-5831-2028 fax: +86-10-5831-2026
(Guangzhou branch) phone: +86-20-3882-0551 fax: +86-20-3882-0580

NIKON INSTRUMENTS KOREA CO., LTD.

KOREA phone: +82-2-2186-8400 fax: +82-2-555-4415

NIKON SINGAPORE PTE. LTD.

SINGAPORE phone: +65-6559-3651 fax: +65-6559-3668
E-mail: NSG.Industrial-sales@nikon.com

PT. NIKON INDONESIA

INDONESIA phone: +62-267-864-3949 fax: +62-267-864-3950
E-mail: PTN.Instruments@nikon.com

NIKON SALES (THAILAND) CO., LTD.

THAILAND phone: +66-2633-5100 fax: +66-2633-5191

NIKON INDIA PRIVATE LIMITED

INDIA phone: +91-124-4688500 fax: +91-124-4688527